

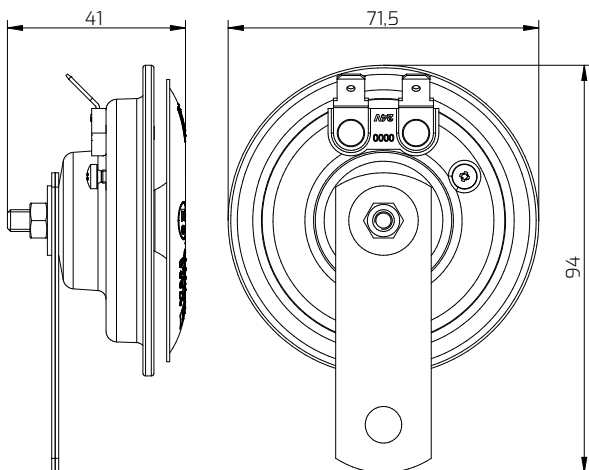

ELECTROMAGNETIC DISC-HORN | $\varnothing 70$

LINE K70 H 6V

Technical drawing



Connection

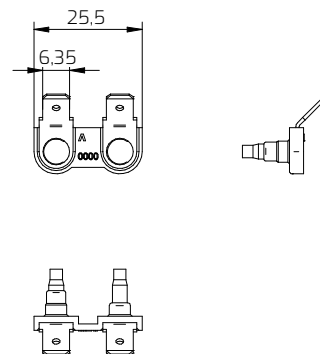

LINE K70 H 6V

Technical features

Nominal Voltage	Vcc	6
Voltage Range	Vcc	5,7÷6,9
Current Consumption	A	<2
Sound Pressure Level (at 2 meters)	dB(A)	108
Frequency (High Tone)	Hz	430
Terminals (No. 2 Faston 6,3 x 0,8mm)	nr	2
Durability (1" On + 4" Off)	cycles	>50.000
Corrosion resistance (UNI 9227)	h	>192
Operating and Storage Temperature	°C	from -30 to +80
Electrical Insulation (at 1000Vcc)	MΩ	>10
Vibrations (30 min x 3 axis)	g	3
Weight including bracket	gr	150

Packing

Single Packing Dimensions	mm	90 x 90 x 60 h
Master Carton Quantity	pcs	48
Master Carton Dimensions	cm	39 x 28 x 27 h
Master Carton Weight	kg	9,6

Mounting Instructions

K70 electromagnetic Disc Horn

To function correctly, the horn must be free to vibrate:

- It is therefore good that there is at least 1 cm around it of space to avoid contact with other surfaces.

The horn must be installed in a vertical position:

- The mechanical connection with the standard linear brackets must be carried out on a flat, rigid surface (possibly metal) for a maximum length of 22 mm.

The horn must be installed in a position protected from:

- sprays of water generated by the movement of the vehicle or by washing systems.
- foreign bodies such as stones, insects, mud, snow, etc.
- excessive heat sources (above 80°) such as radiators, exhaust pipes, engines.

ATTENTION!

We recommend the utmost care in managing the installation phase, avoiding:

- tampering with the horn diffuser disc which can cause deformation of the thin membrane compromising its functioning in terms of frequency and sound level
- the horn falls to the ground which can lead to its misalignment.
- interventions on the adjustment/calibration screw of the horn.

